

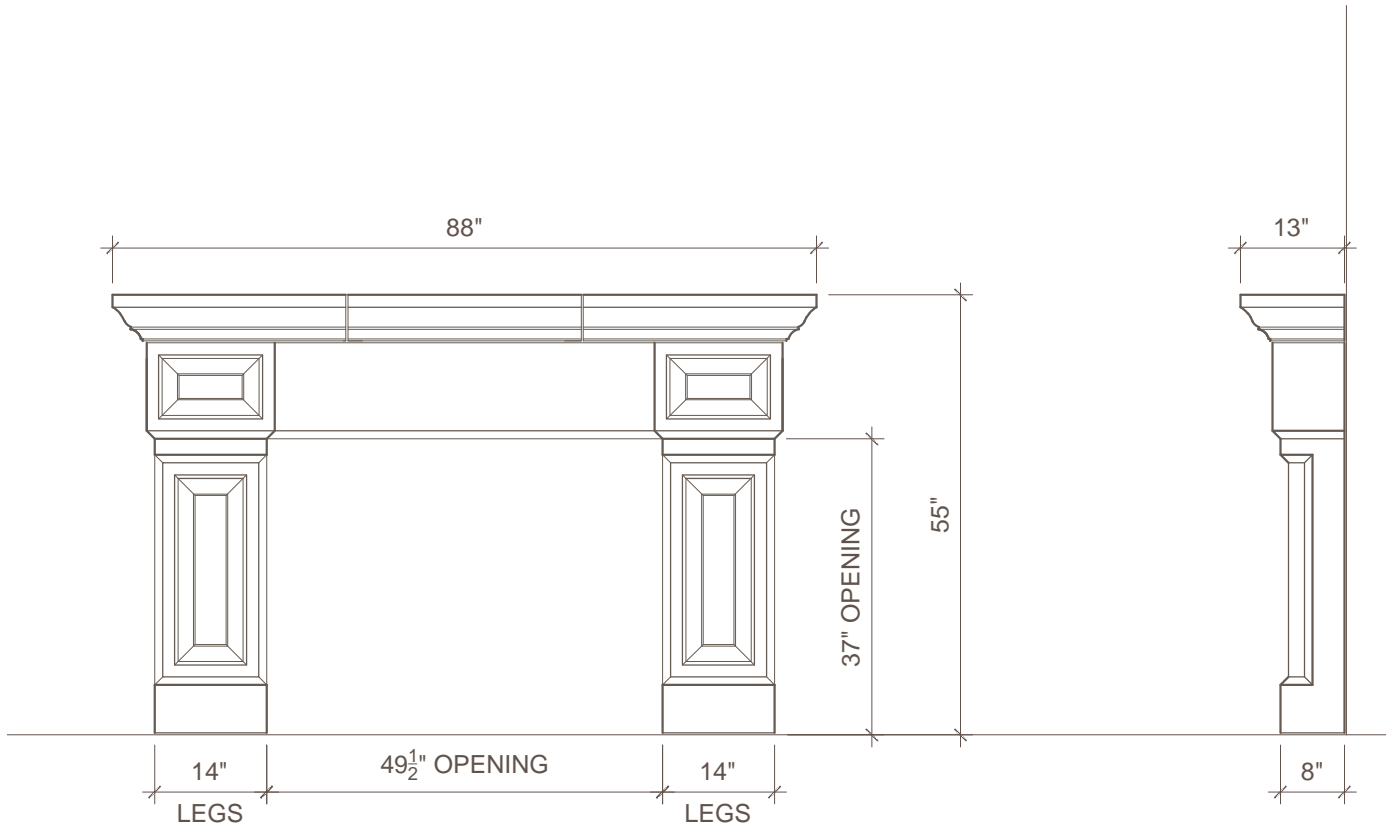

# THE MANCHESTER



**1 FRONT**  
SCALE: 1/2"=1'-0"

**2 SIDE**  
SCALE: 1/2"=1'-0"

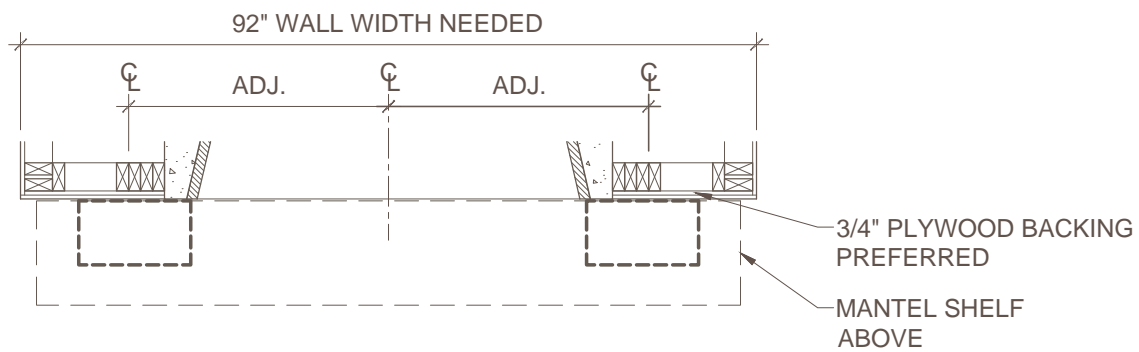

**3 FRAMING PLAN**  
SCALE: 1/2"=1'-0"

\*ALL JOINTS ARE AT 1/4" UNLESS NOTED OTHERWISE

# HEARTH OPTIONS

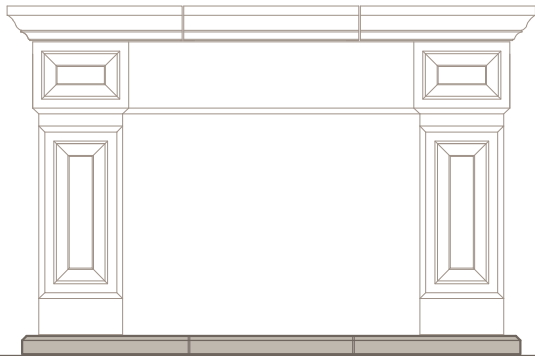

CHAMFERED EDGE  
SQUARE HEARTH

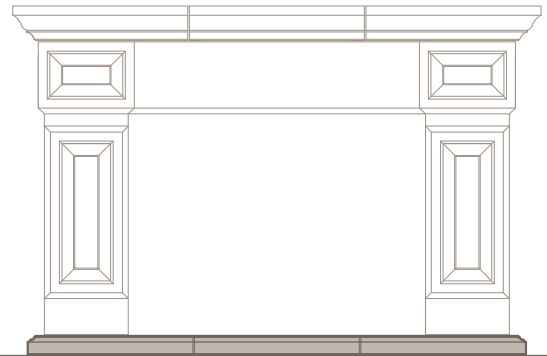

OGEE EDGE  
SQUARE HEARTH

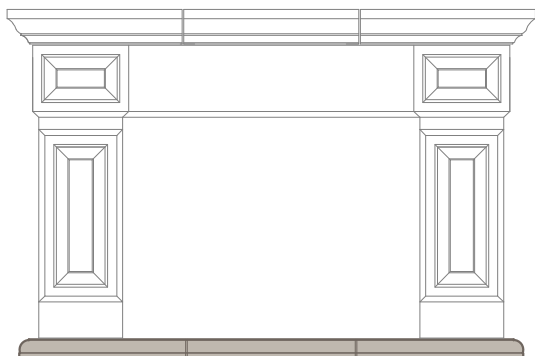

RADIUS EDGE  
EYEBROW HEARTH\*



\*SIZES LIMITED FOR EYEBROW HEARTH

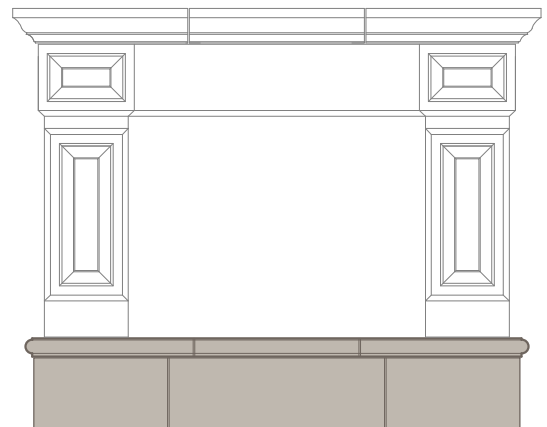

BULLNOSE EDGE, SQUARE  
HEARTH WITH RAISED PANELS



*VISIT OPTIONS PAGE FOR MORE INFORMATION*

# FILLER PANEL OPTIONS

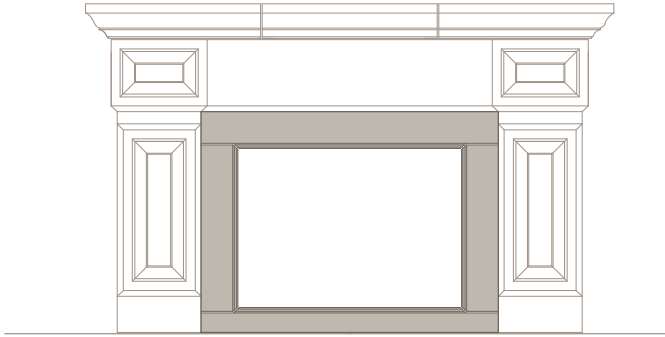

OGEE EDGE, STRAIGHT  
FILLER PANEL

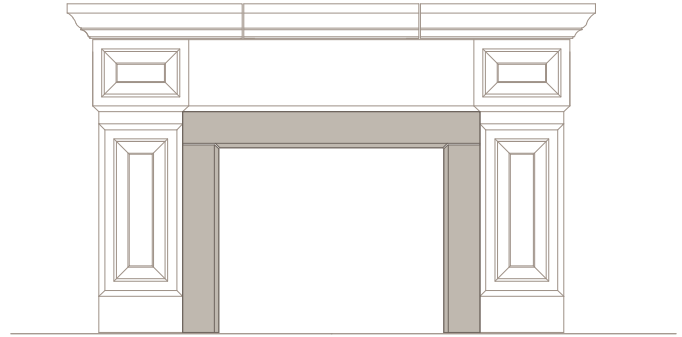

CHAMFER EDGE, STRAIGHT  
FILLER PANEL \*

\*SHOWN WITHOUT BOTTOM PANEL

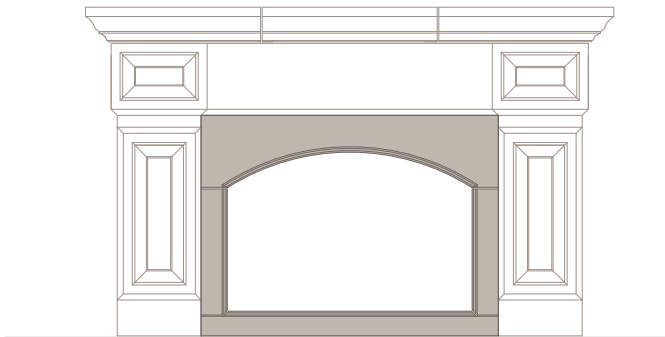

OGEE EDGE, EYEBROW  
FILLER PANEL \*\*

\*\*SIZES LIMITED FOR EYEBROW FILLER PANELS

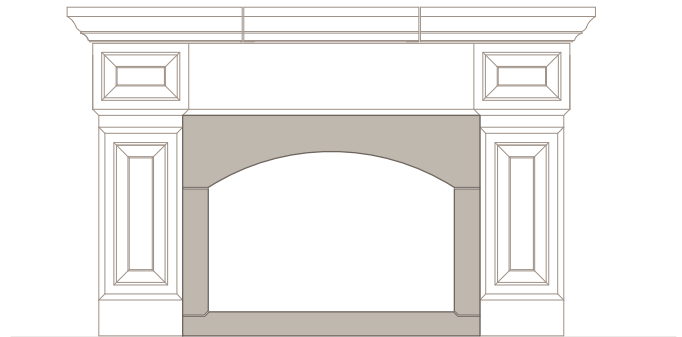

SQUARE EDGE, EYEBROW  
FILLER PANEL \*\*

*VISIT OPTIONS PAGE FOR MORE INFORMATION*



4520 S. MacArthur Blvd. OKC, OK 73179

Ph: 405.680.5600 Fax: 405.680.9314

Web: [devincicaststone.com](http://devincicaststone.com)