

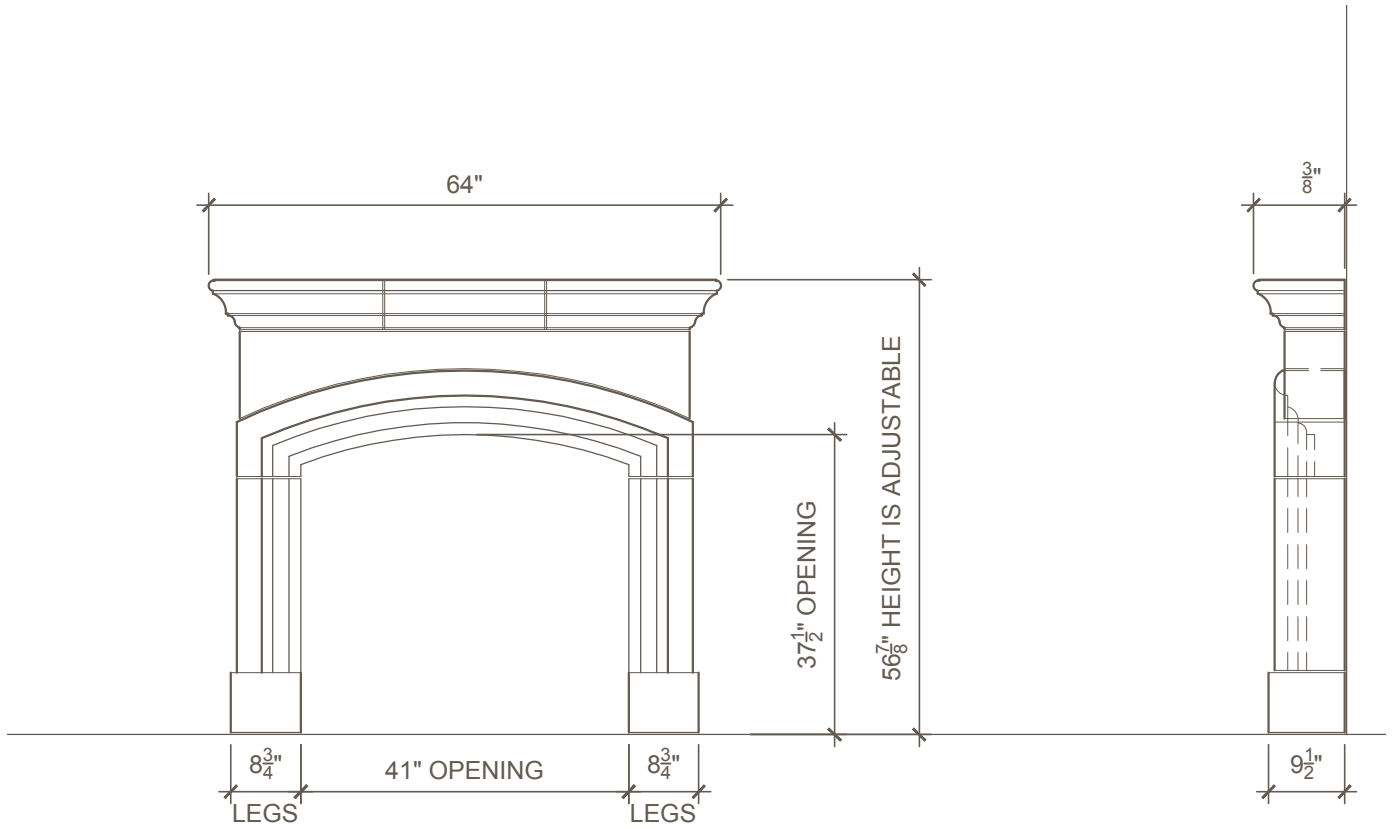

THE YORKSHIRE



1 FRONT
SCALE: 1/2"=1'-0"

2 SIDE
SCALE: 1/2"=1'-0"

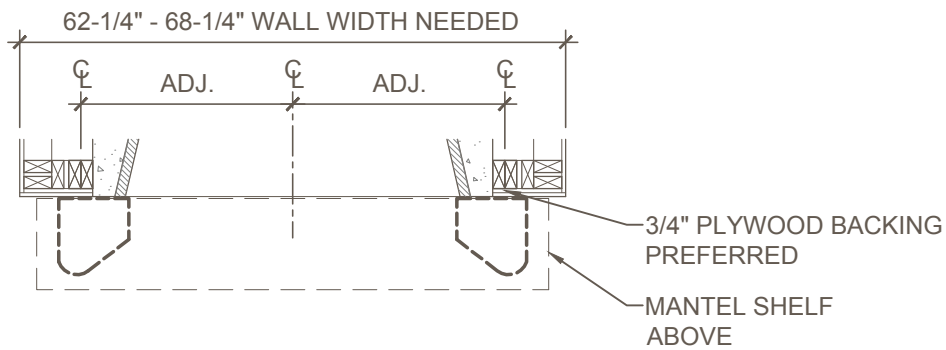

3 FRAMING PLAN
SCALE: 1/2"=1'-0"

*ALL JOINTS ARE AT 1/4" UNLESS NOTED OTHERWISE

HEARTH OPTIONS

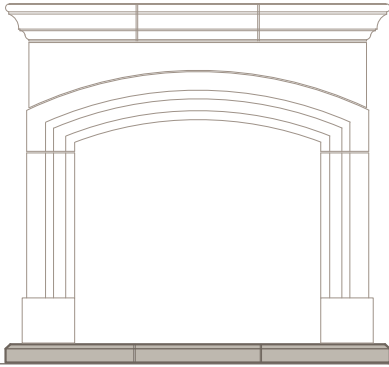

CHAMFERED EDGE
SQUARE HEARTH

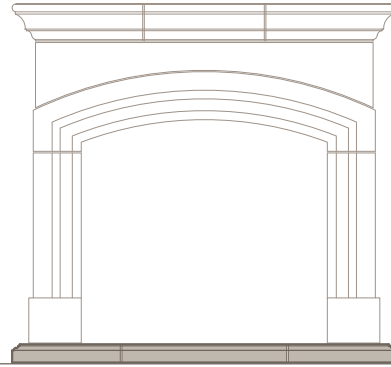

OGEE EDGE
SQUARE HEARTH

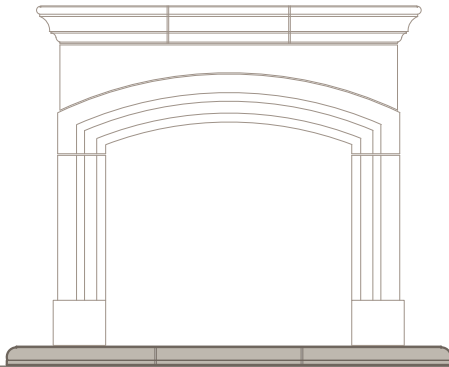

RADIUS EDGE
EYEBROW HEARTH*

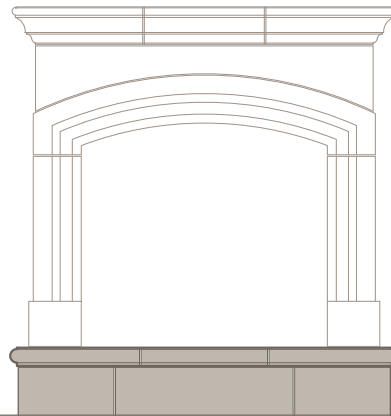

BULLNOSE EDGE, SQUARE
HEARTH WITH RAISED PANELS



*SIZES LIMITED FOR EYEBROW HEARTH

VISIT OPTIONS PAGE FOR MORE INFORMATION

FILLER PANEL OPTIONS

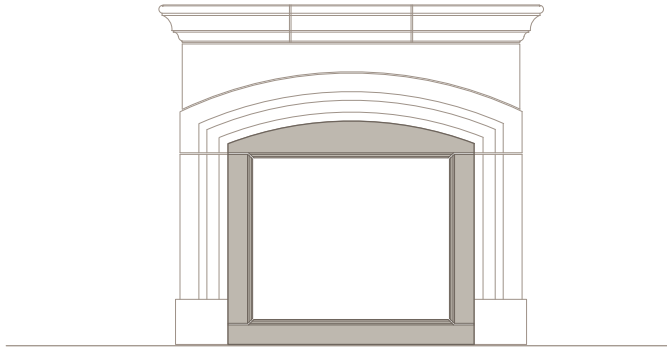

OGEE EDGE, STRAIGHT
FILLER PANEL

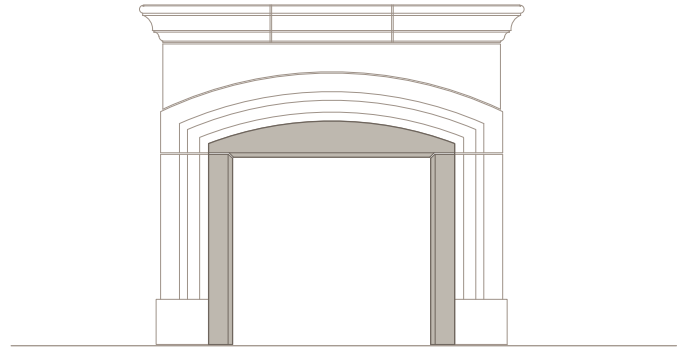

CHAMFER EDGE, STRAIGHT
FILLER PANEL *

*SHOWN WITHOUT BOTTOM PANEL

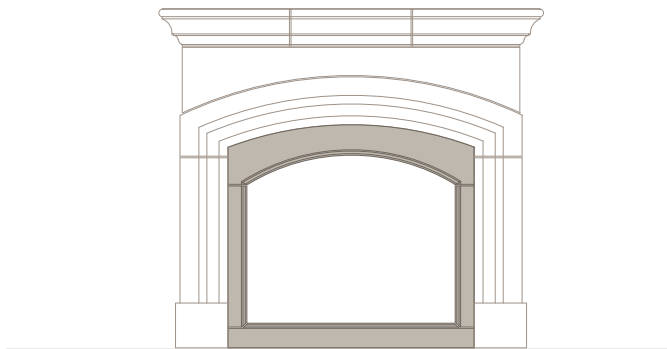

OGEE EDGE, EYEBROW
FILLER PANEL **

**SIZES LIMITED FOR EYEBROW FILLER PANELS,
SHOWN WITHOUT CENTER HEADER PIECE

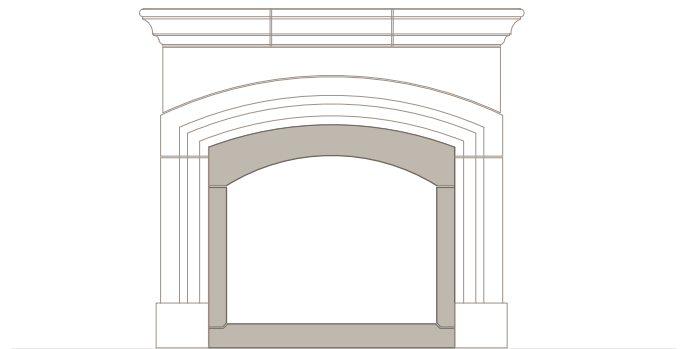

SQUARE EDGE, EYEBROW
FILLER PANEL **

VISIT OPTIONS PAGE FOR MORE INFORMATION



4520 S. MacArthur Blvd. OKC, OK 73179

Ph: 405.680.5600 Fax: 405.680.9314

Web: devincicaststone.com